

StudentenSTAALprijs  
Prix ACIER Etudiant  
2013-2014

16 deelnemende projecten

16 projets participants

*Thema : 'vlak staal'*

*Thème : 'acier plat'*

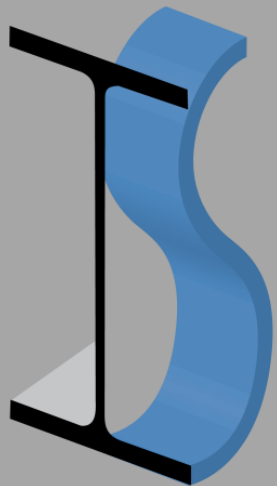

StudentenSTAALprijs

Prix ACIER Etudiant

2013-2014



Coney Island Revisited: A resilient network  
Ruben Janssens

KU Leuven - Campus Sint-Lucas







Het gebouw ontleed: architectuurdetail  
Niels Algoedt, Pieter-Jan Persoons  
KU Leuven - Campus Sint-Lucas

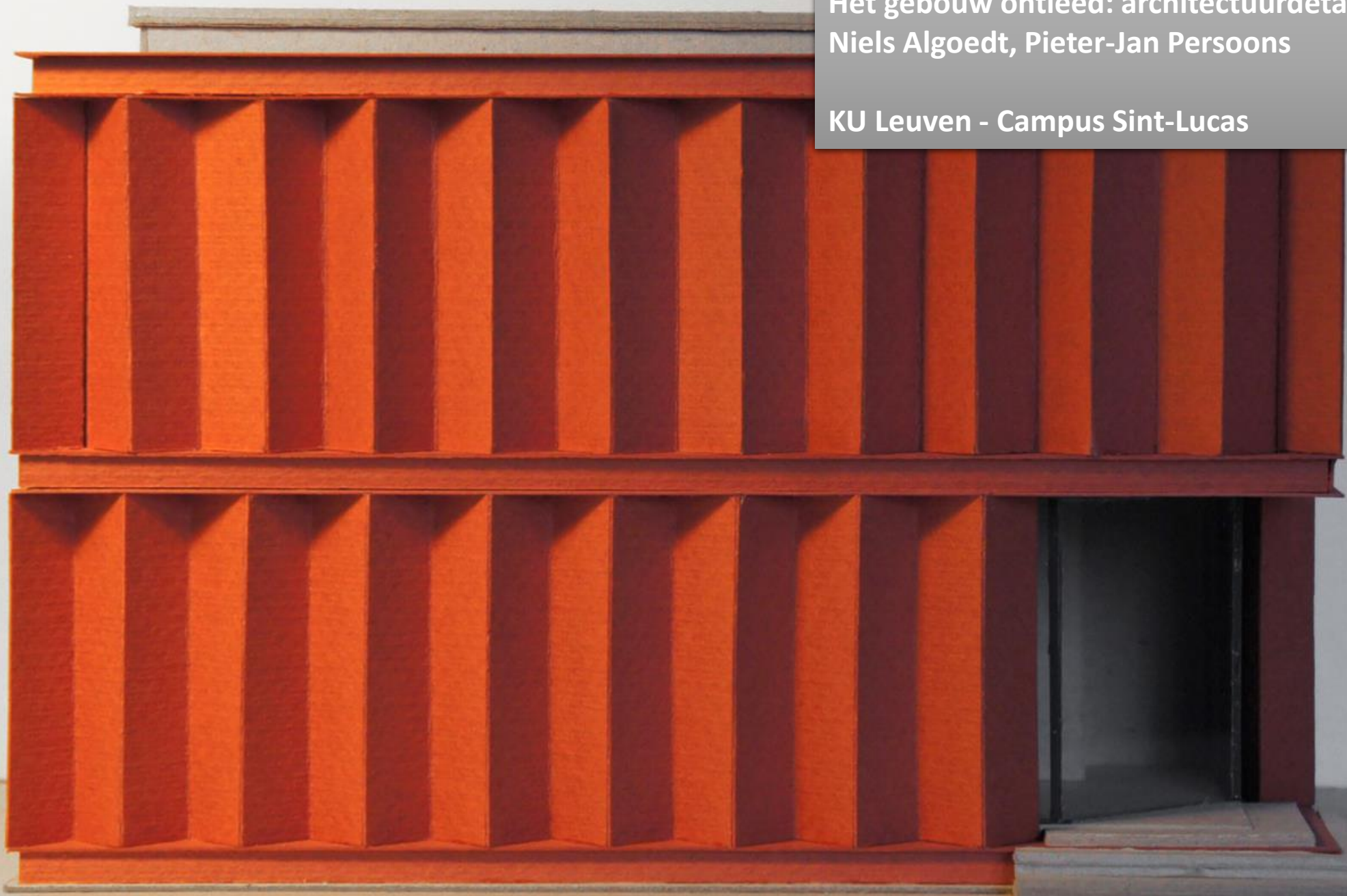



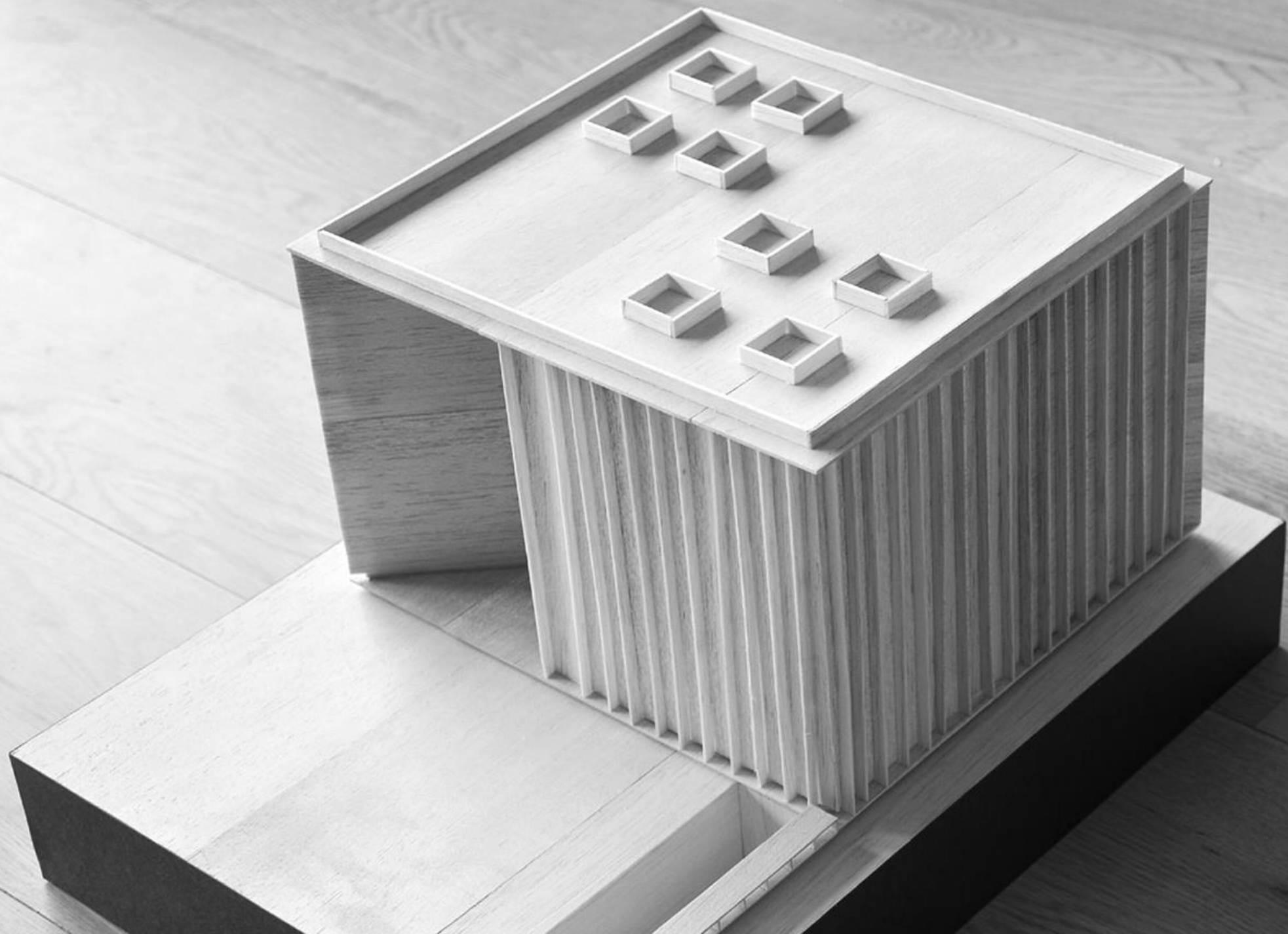

Het gebouw ontleed: architectuurdetail  
Evelyne Baeten, Jonas Hylebos  
KU Leuven - Campus Sint-Lucas









Het gebouw ontleed: architectuurdetail  
Samuel Hermans, Melissa Denis, Lisa Keller  
KU Leuven - Campus Sint-Lucas





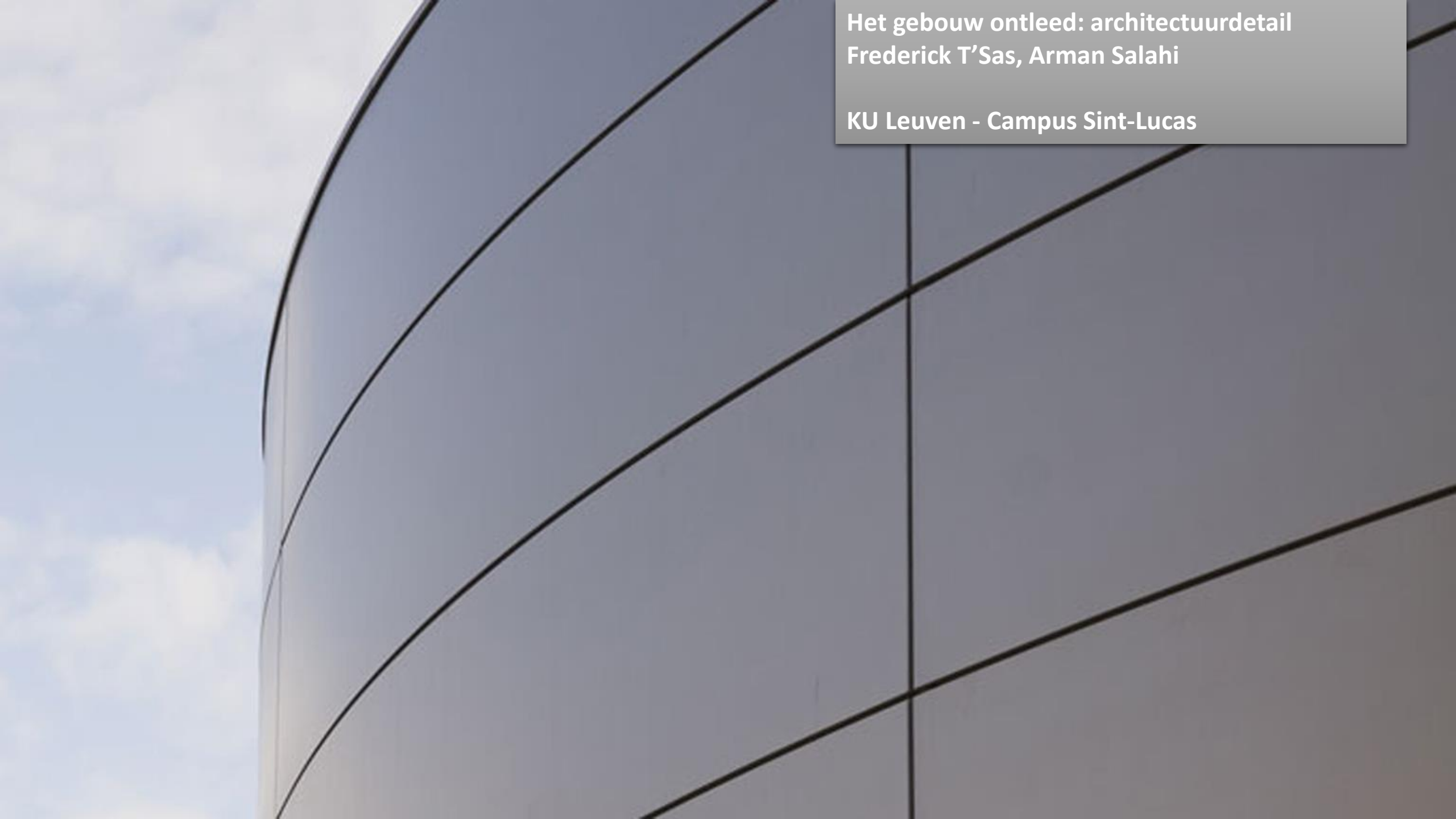

Het gebouw ontleed: architectuurdetail  
Frederick T'Sas, Arman Salahi

KU Leuven - Campus Sint-Lucas

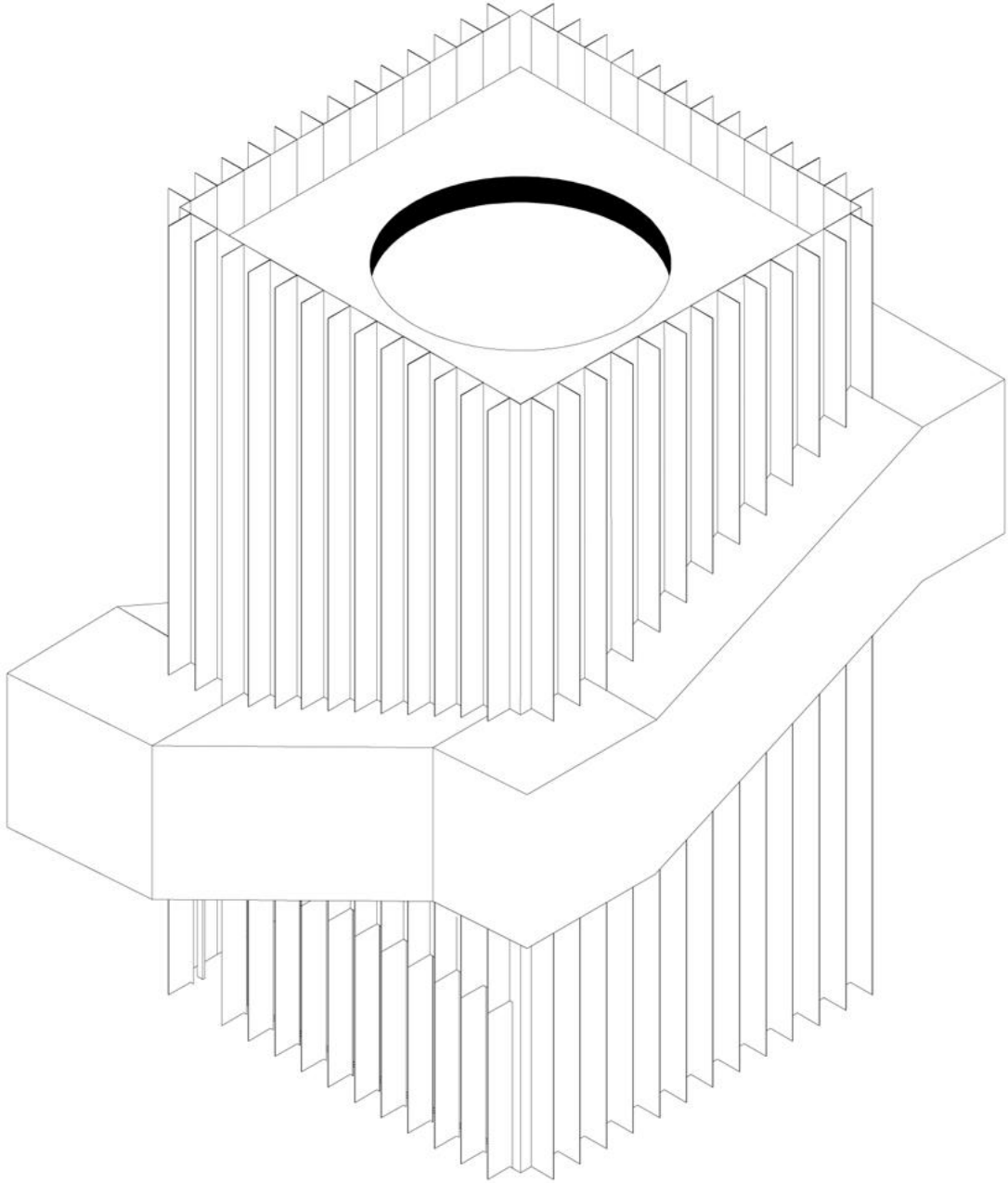

Het gebouw ontleed: architectuurdetail  
Jonas Vanbelle, Silke Van Damme

KU Leuven - Campus Sint-Lucas

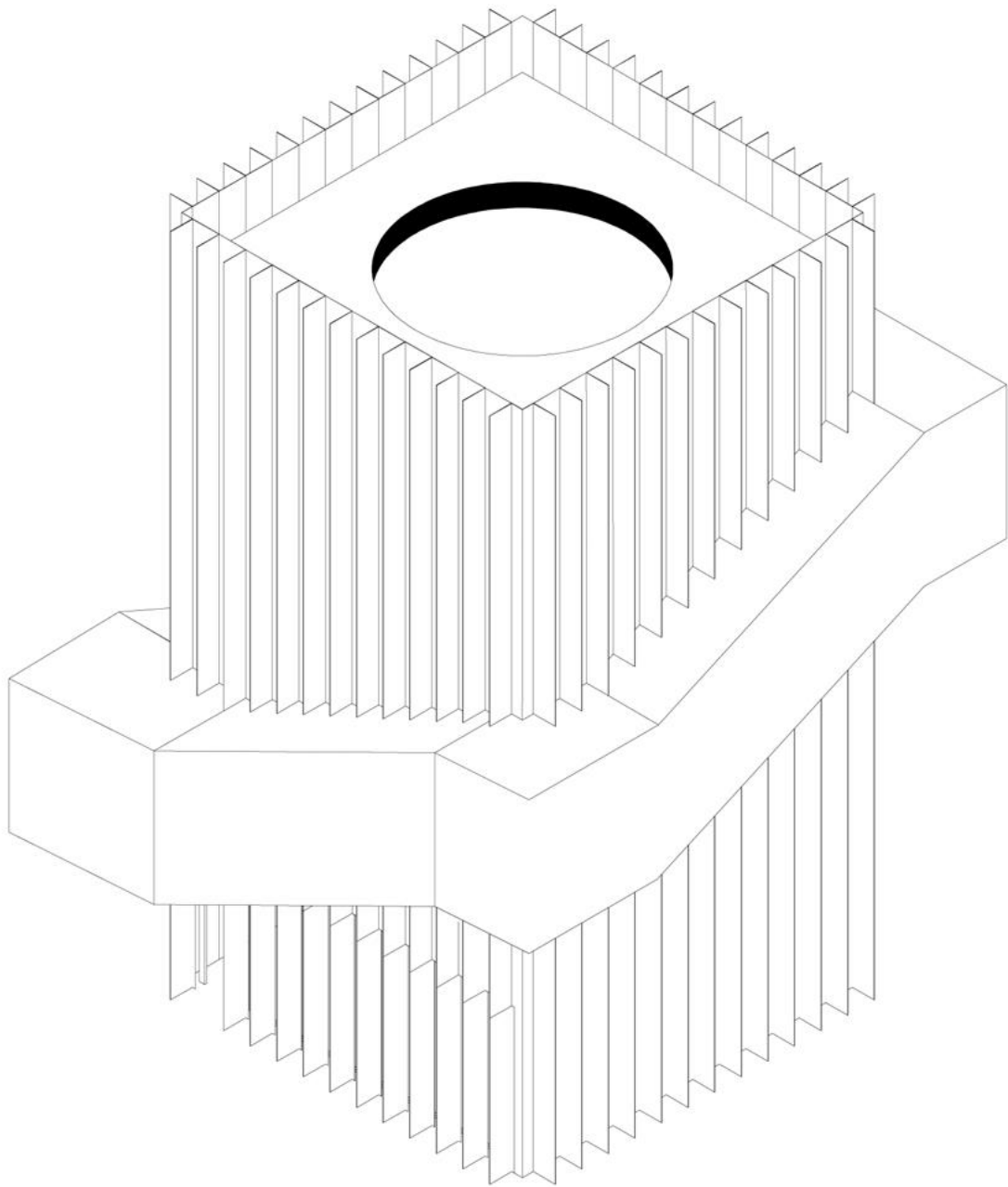



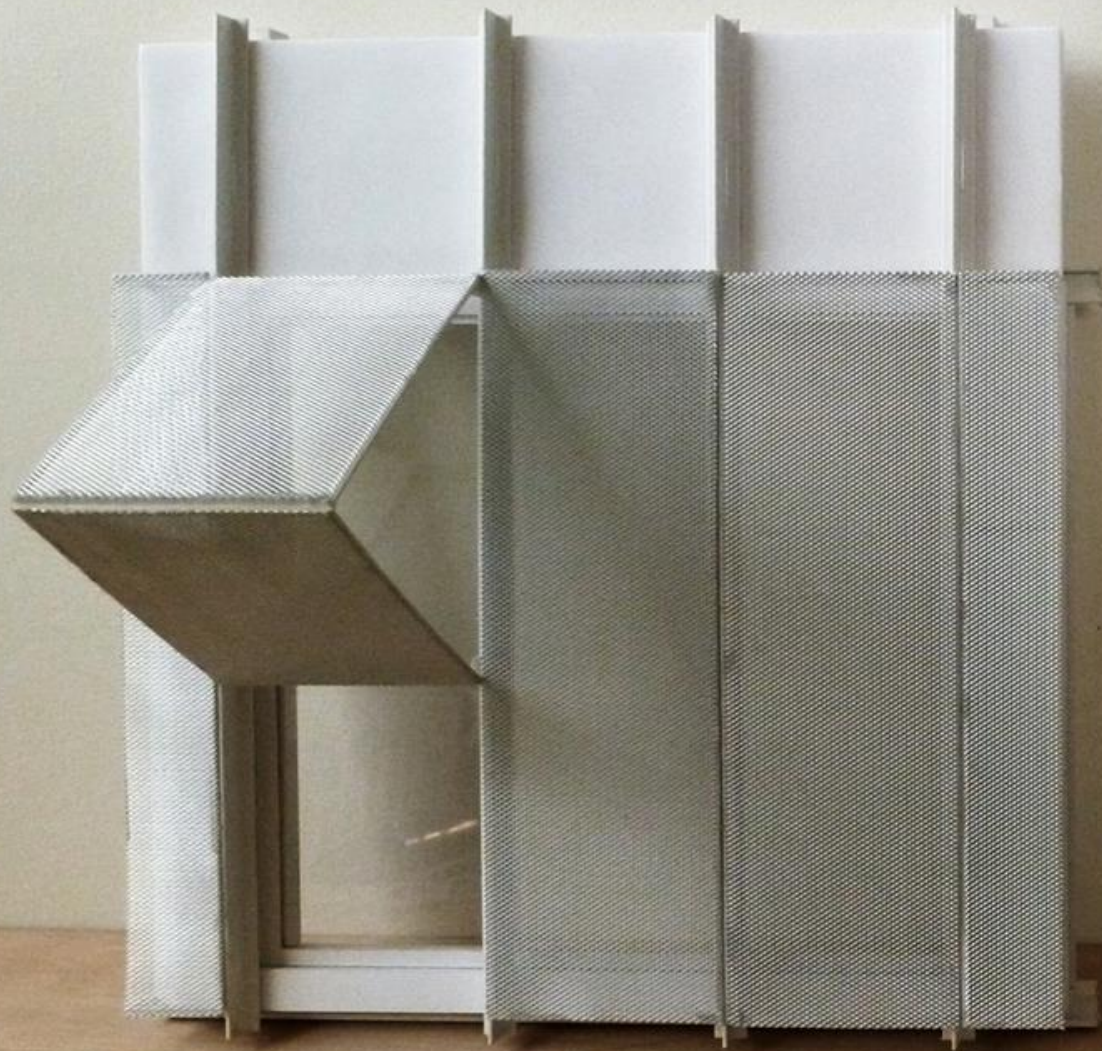



Het gebouw ontleed: architectuurdetail  
Michiel Van Gucht, Dieter Van Hemelrijck

KU Leuven - Campus Sint-Lucas







RE3 TO ALGA

SeaLand HYUNDAI MAERSK SEALAND HYUNDAI

COLORADO



RE<sup>3</sup> to algae  
Giel Theuwis

Universiteit Hasselt - Campus Diepenbeek

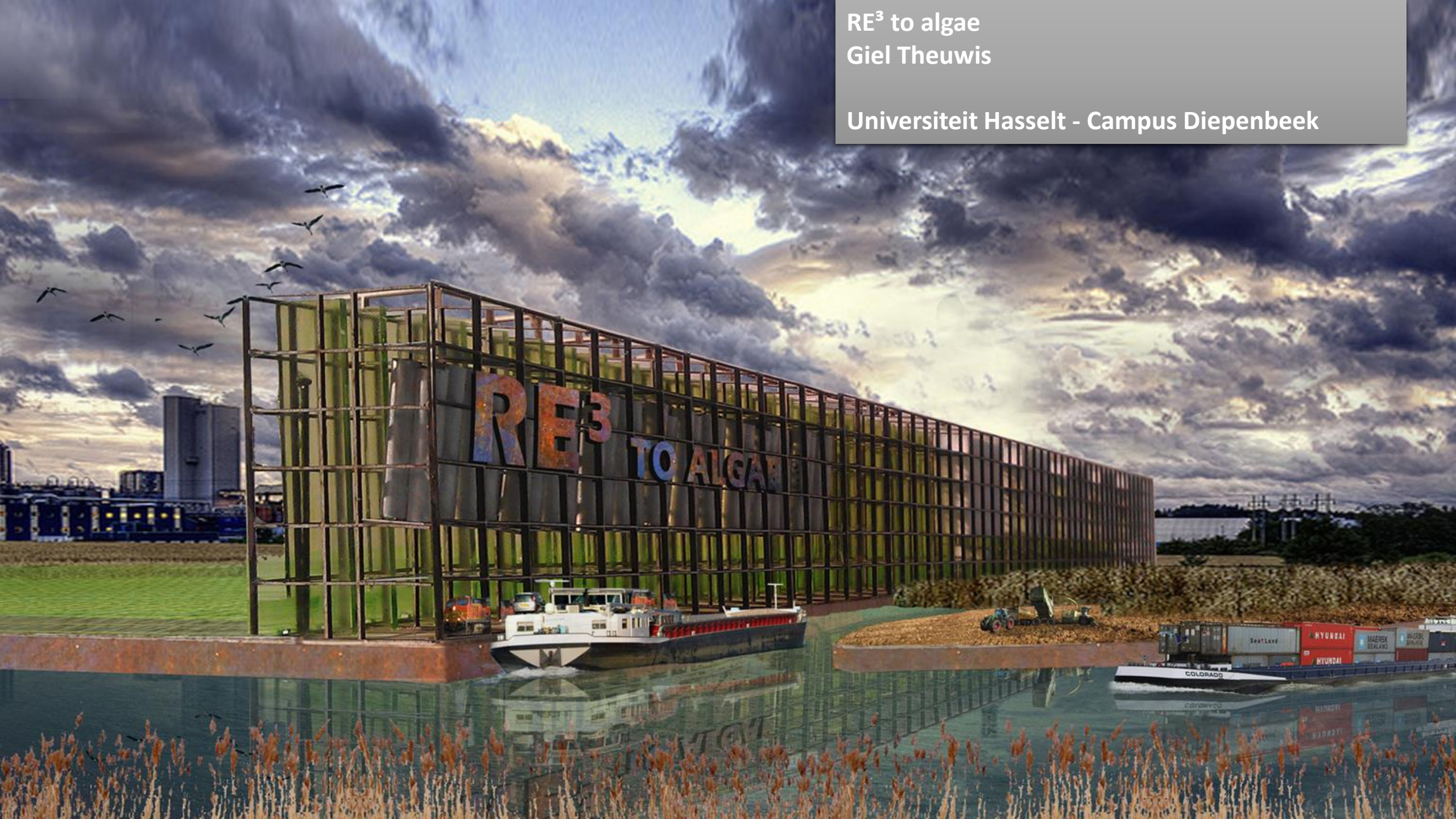





CRAMER  
ROBERT

OPERA

OPERA



Illusion is the first of all pleasures

Kasper Konings

Universiteit Hasselt - Campus Diepenbeek

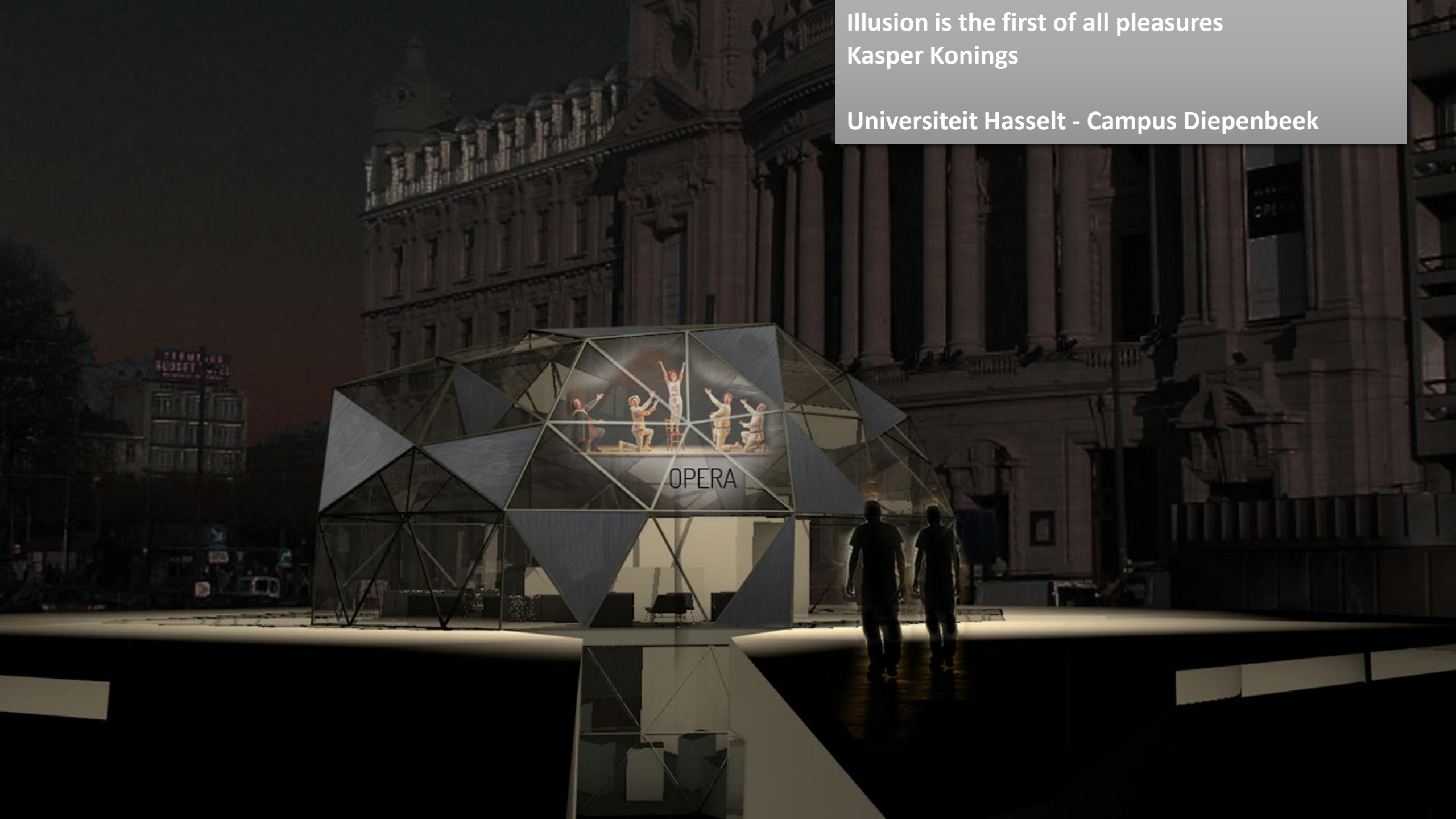







K12 Universitair Ziekenhuis Gent  
Jorn De Kegel, Simon Kaisin  
UGent









K12 Universitair Ziekenhuis Gent  
Joeri Sinnaeve, Toon Van Mieghem  
UGent









K12 Universitair Ziekenhuis Gent  
Sam Bouten, Charlotte De Vreese,  
Michiel Van Der Elst

UGent



4 genomineerde projecten  
4 projets nominés

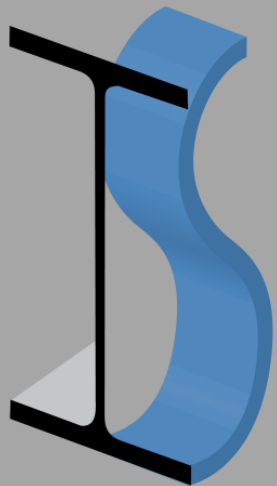

StudentenSTAALprijs  
Prix ACIER Etudiant  
2013-2014



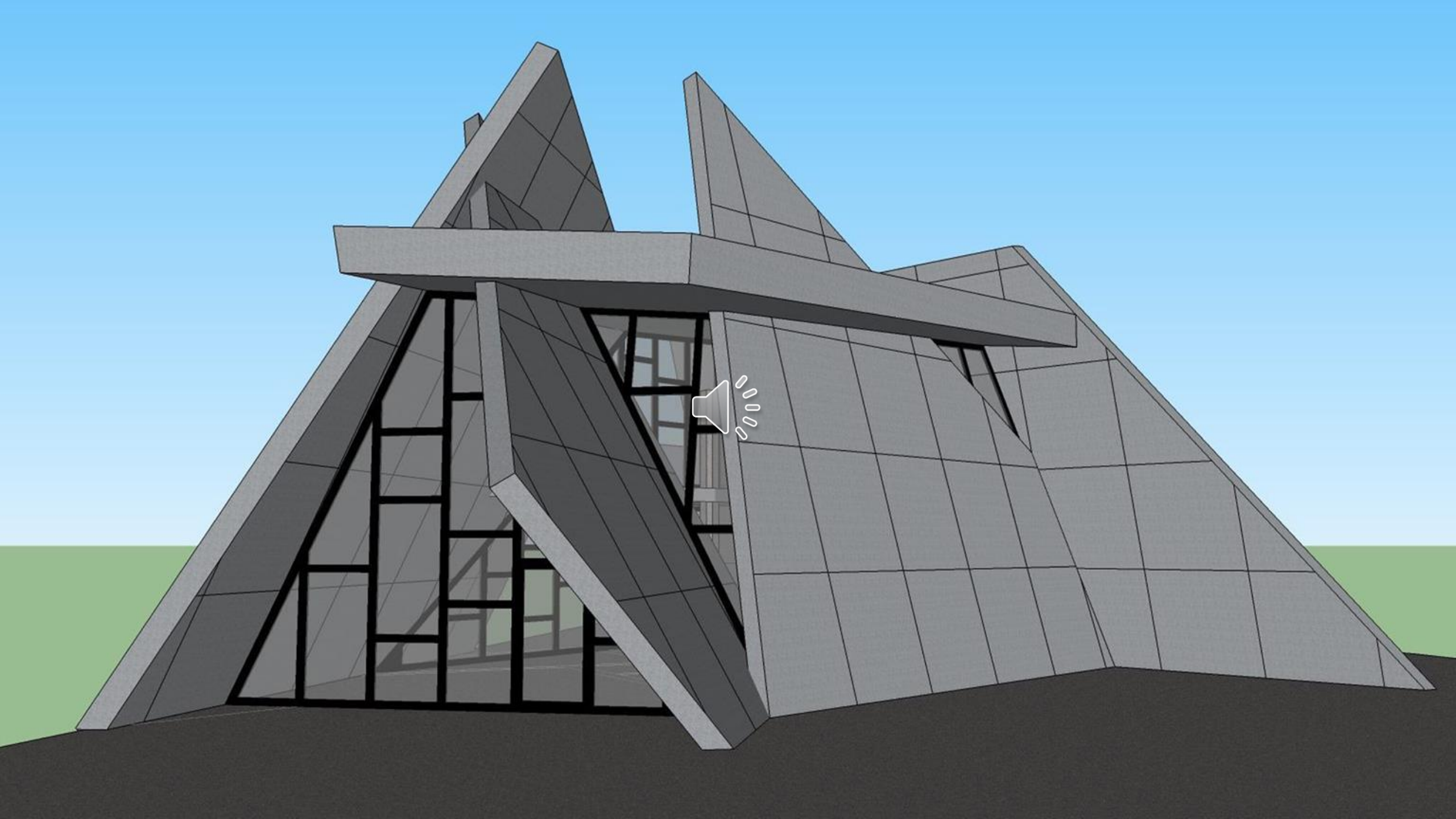

Paviljoen Jubelpark  
Anton Leonov, Celia Tesseur  
KU Leuven - Campus Sint-Lucas





Paviljoen Jubelpark  
Anton Leonov, Celia Tesseur

KU Leuven - Campus Sint-Lucas

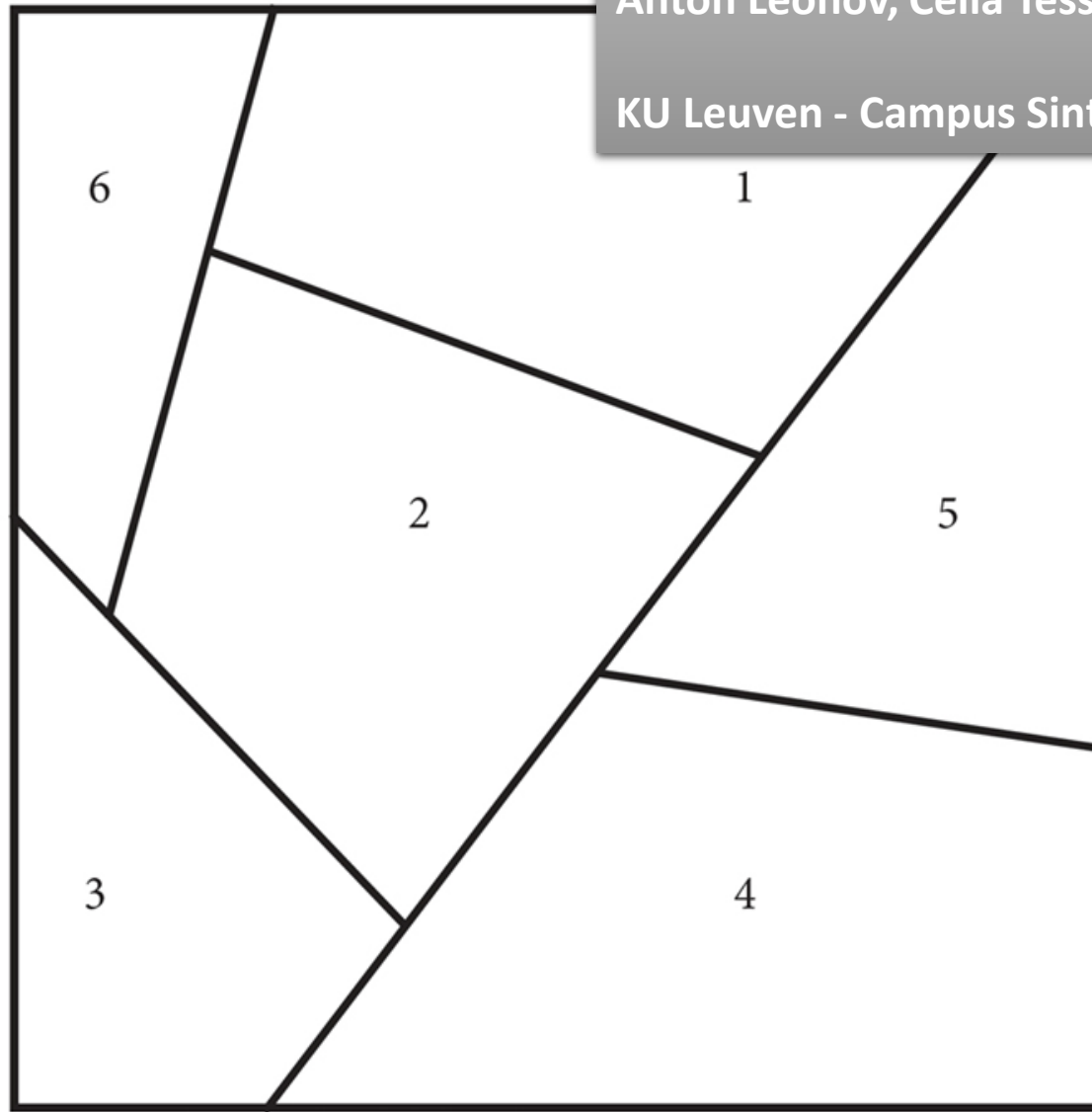

# Paviljoen Jubelpark Anton Leonov, Celia Tesseur

KU Leuven - Campus Sint-Lucas

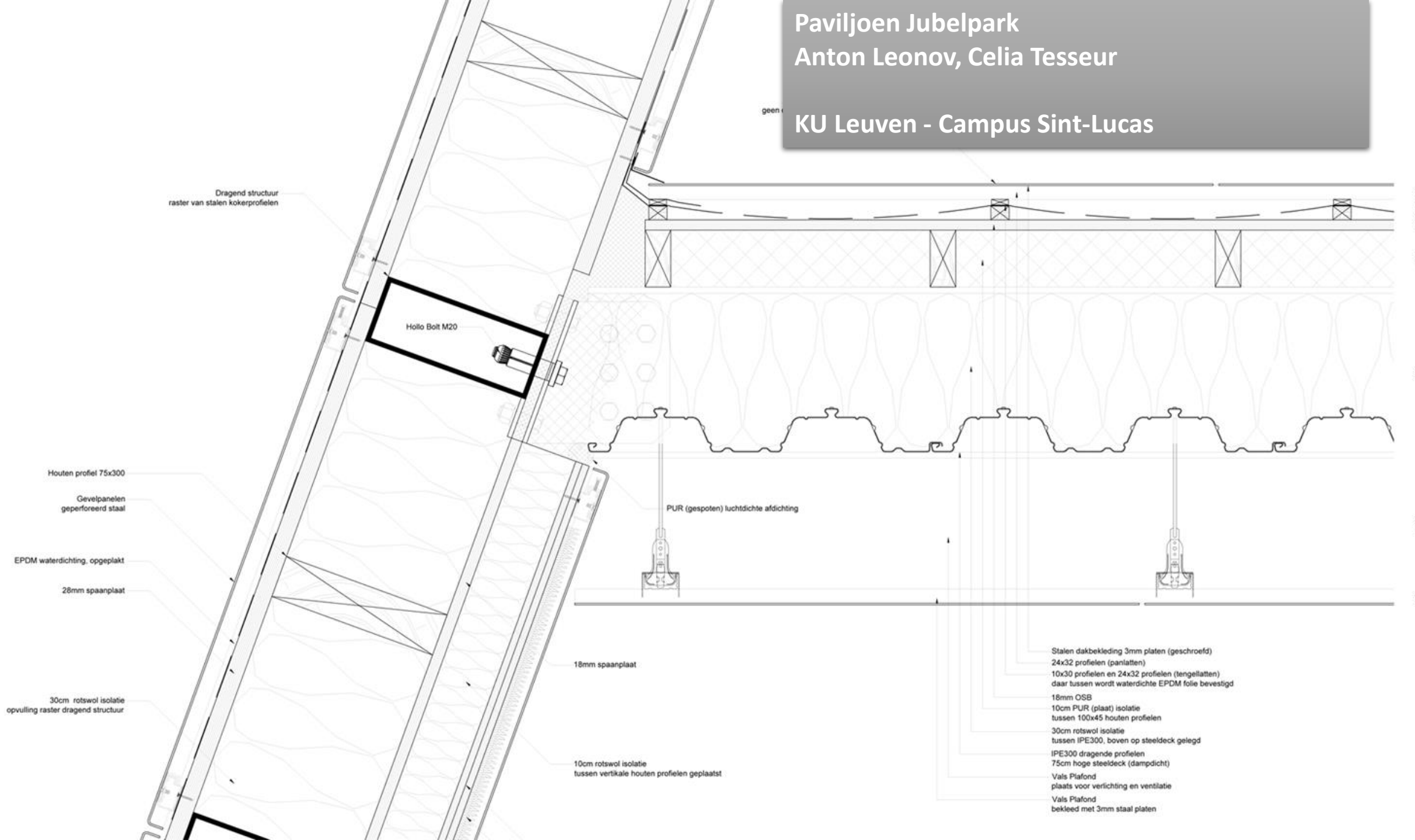

Dragend structuur raster van stalen kokerprofielen

Hollo Bolt M20

Houten profiel 75x300

Gevelpanelen geperforeerd staal

EPDM waterdichting, opgeplakt

28mm spaanplaat

30cm rotswol isolatie opvulling raster dragend structuur

18mm spaanplaat

10cm rotswol isolatie tussen verticale houten profielen geplaatst

PUR (gespoten) luchtdichte afdichting

Stalen dakbekleding 3mm platen (geschroefd)  
24x32 profielen (panlatten)  
10x30 profielen en 24x32 profielen (tengellatten)  
daar tussen wordt waterdichte EPDM folie bevestigd  
18mm OSB  
10cm PUR (plaat) isolatie  
tussen 100x45 houten profielen  
30cm rotswol isolatie  
tussen IPE300, boven op steeldeck gelegd  
IPE300 dragende profielen  
75cm hoge steeldeck (dampdicht)  
Vals Plafond  
plaats voor verlichting en ventilatie  
Vals Plafond  
bekleed met 3mm staal platen



Paviljoen Jubelpark  
Anton Leonov, Celia Tesseur  
KU Leuven - Campus Sint-Lucas

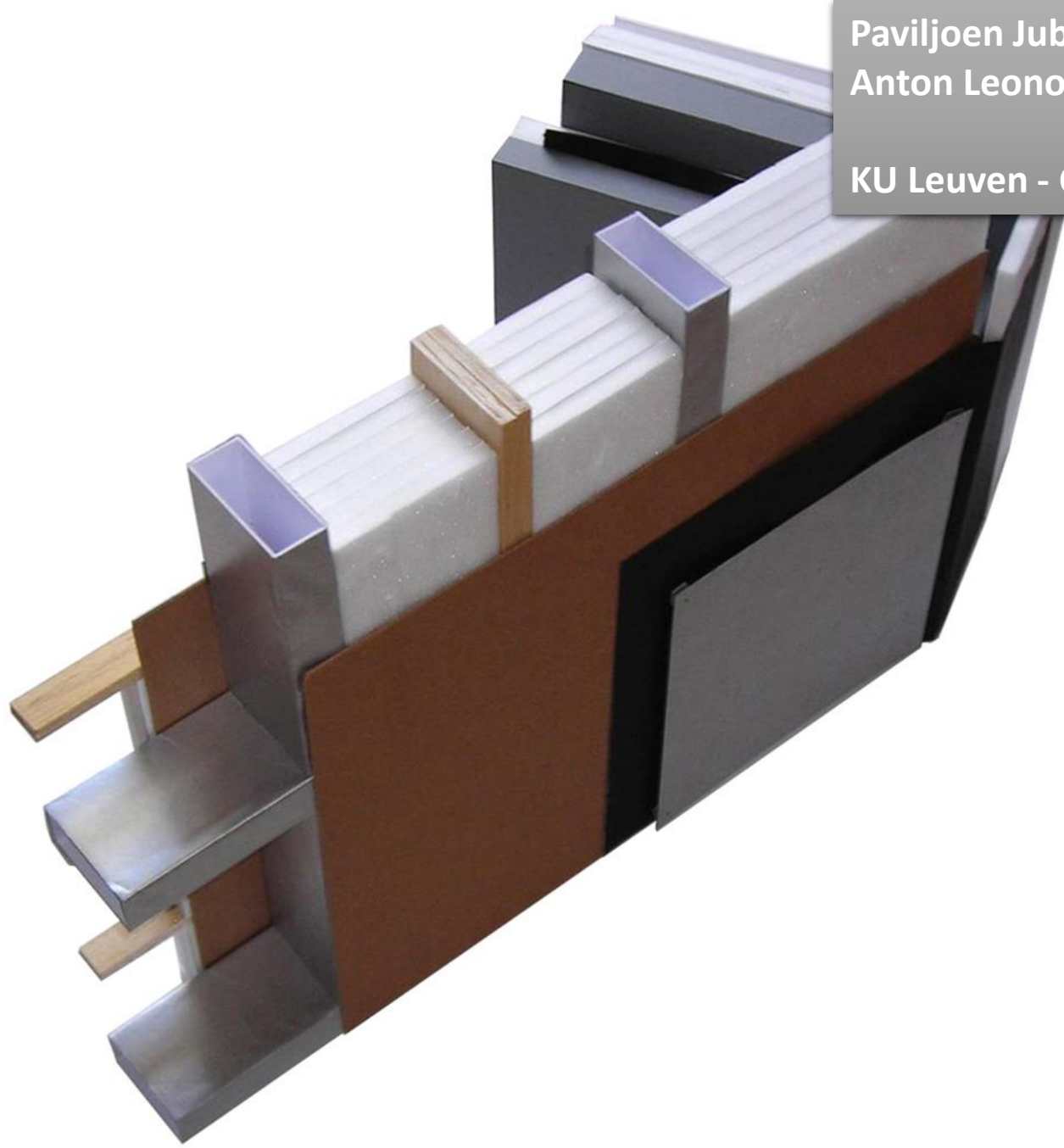

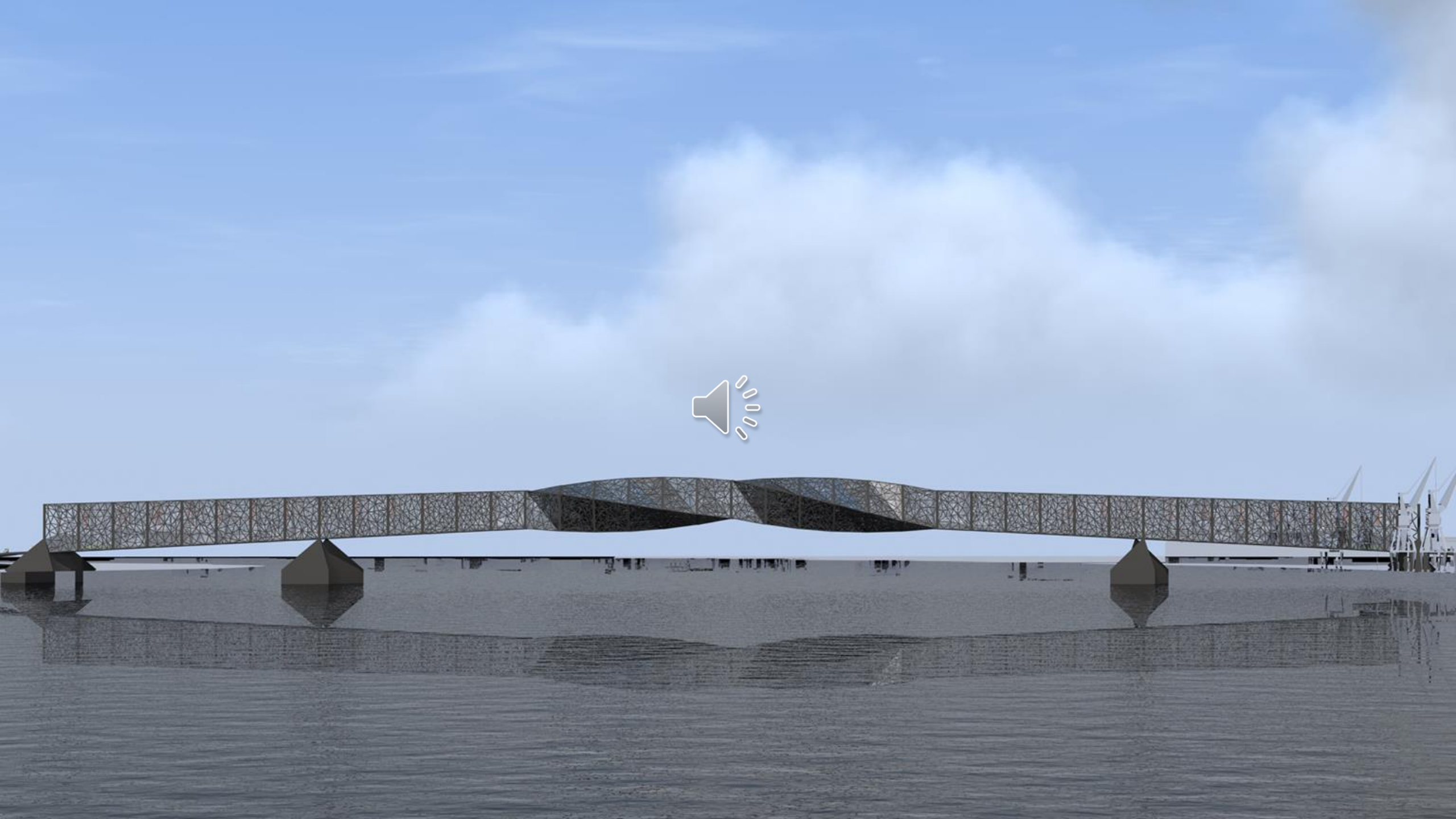



Museum-brug in Antwerpen  
Katleen Coenen

Universiteit Hasselt - Campus Diepenbeek

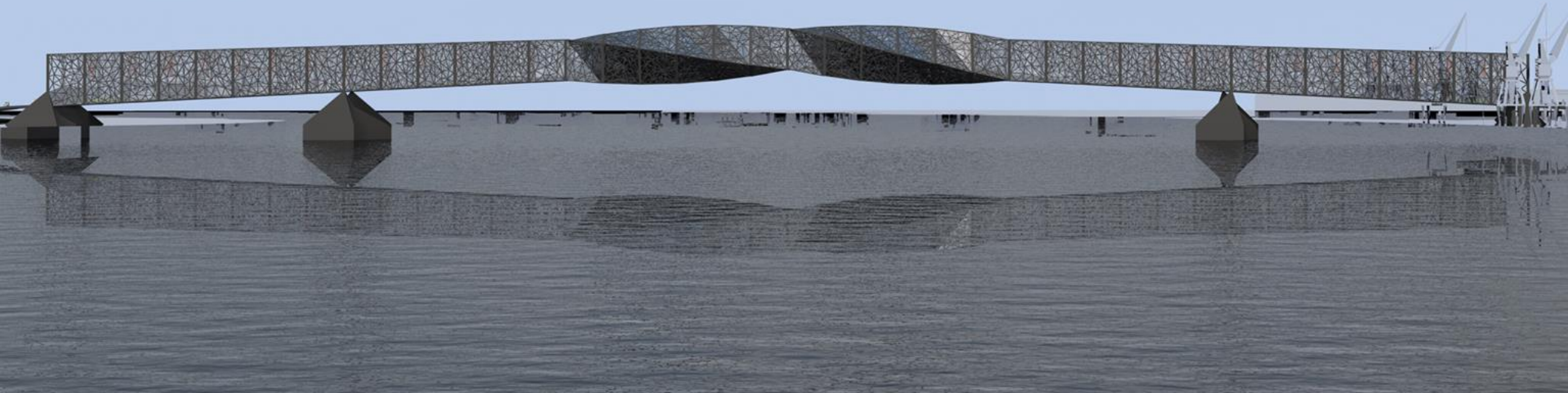



Museum-brug in Antwerpen  
Katleen Coenen

Universiteit Hasselt - Campus Diepenbeek

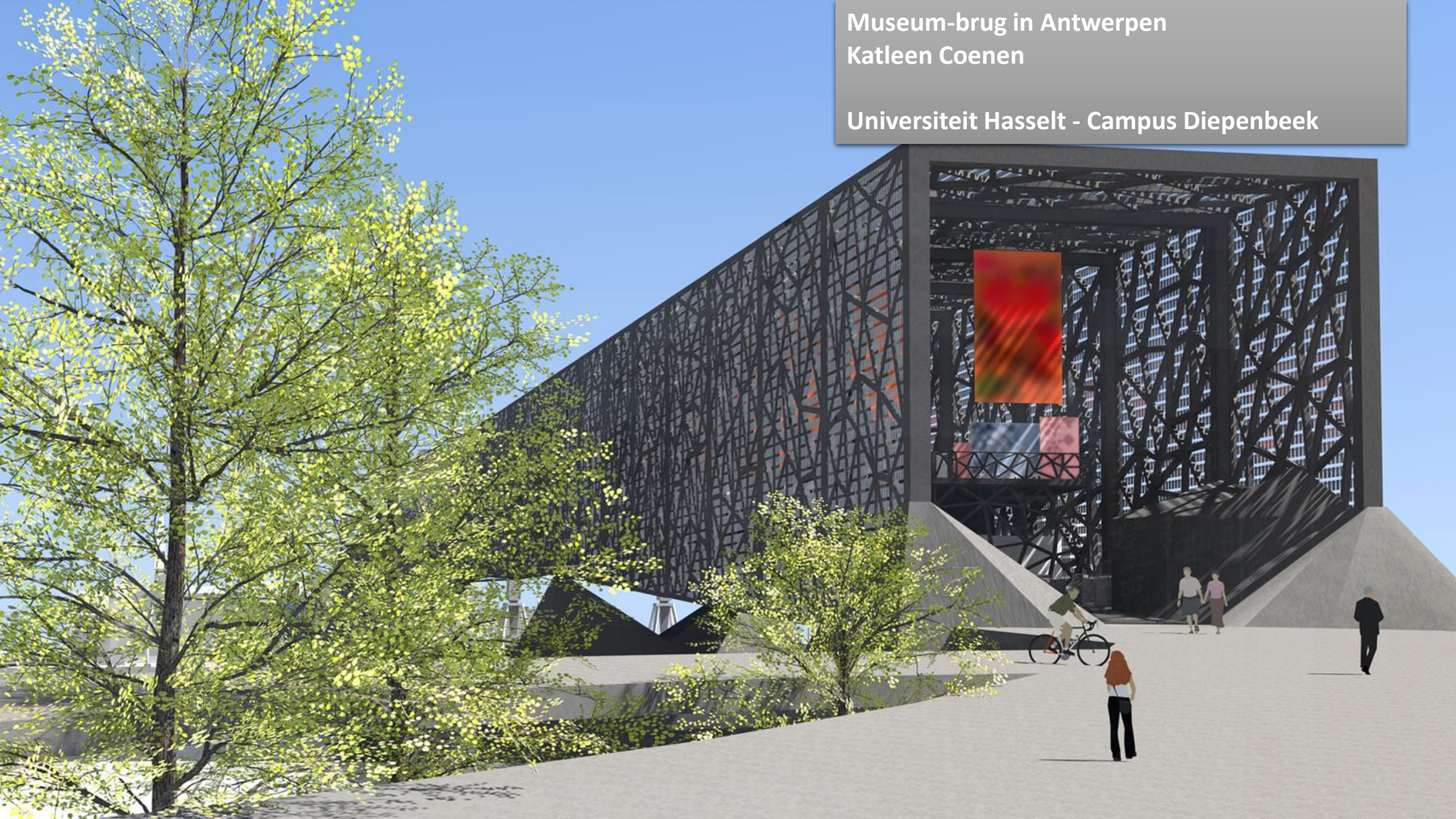



Museum-brug in Antwerpen  
Katleen Coenen

Universiteit Hasselt - Campus Diepenbeek





Museum-brug in Antwerpen  
Katleen Coenen

Universiteit Hasselt - Campus Diepenbeek

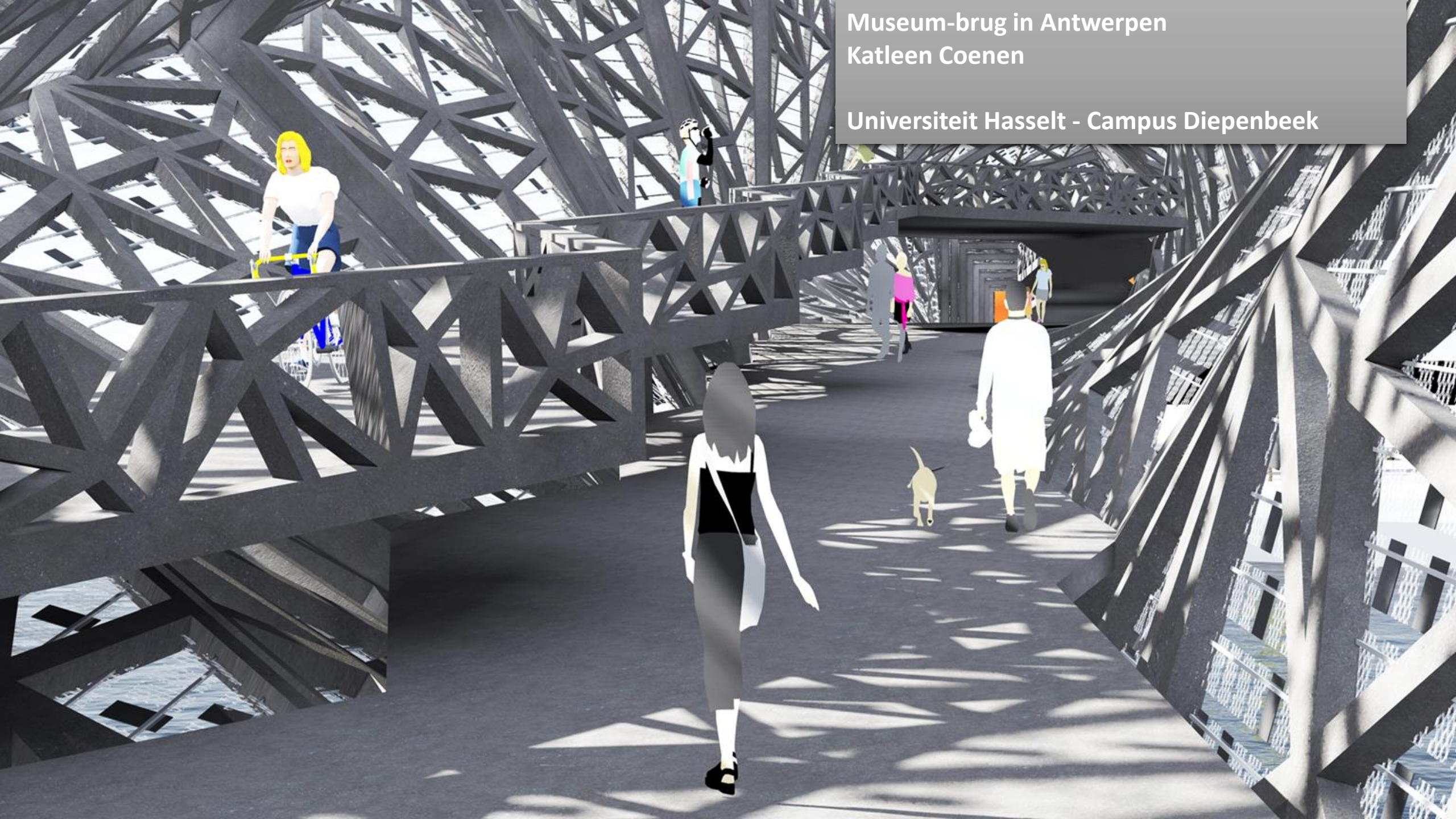



Museum-brug in Antwerpen  
Katleen Coenen

Universiteit Hasselt - Campus Diepenbeek





Museum-brug in Antwerpen  
Katleen Coenen

Universiteit Hasselt - Campus Diepenbeek

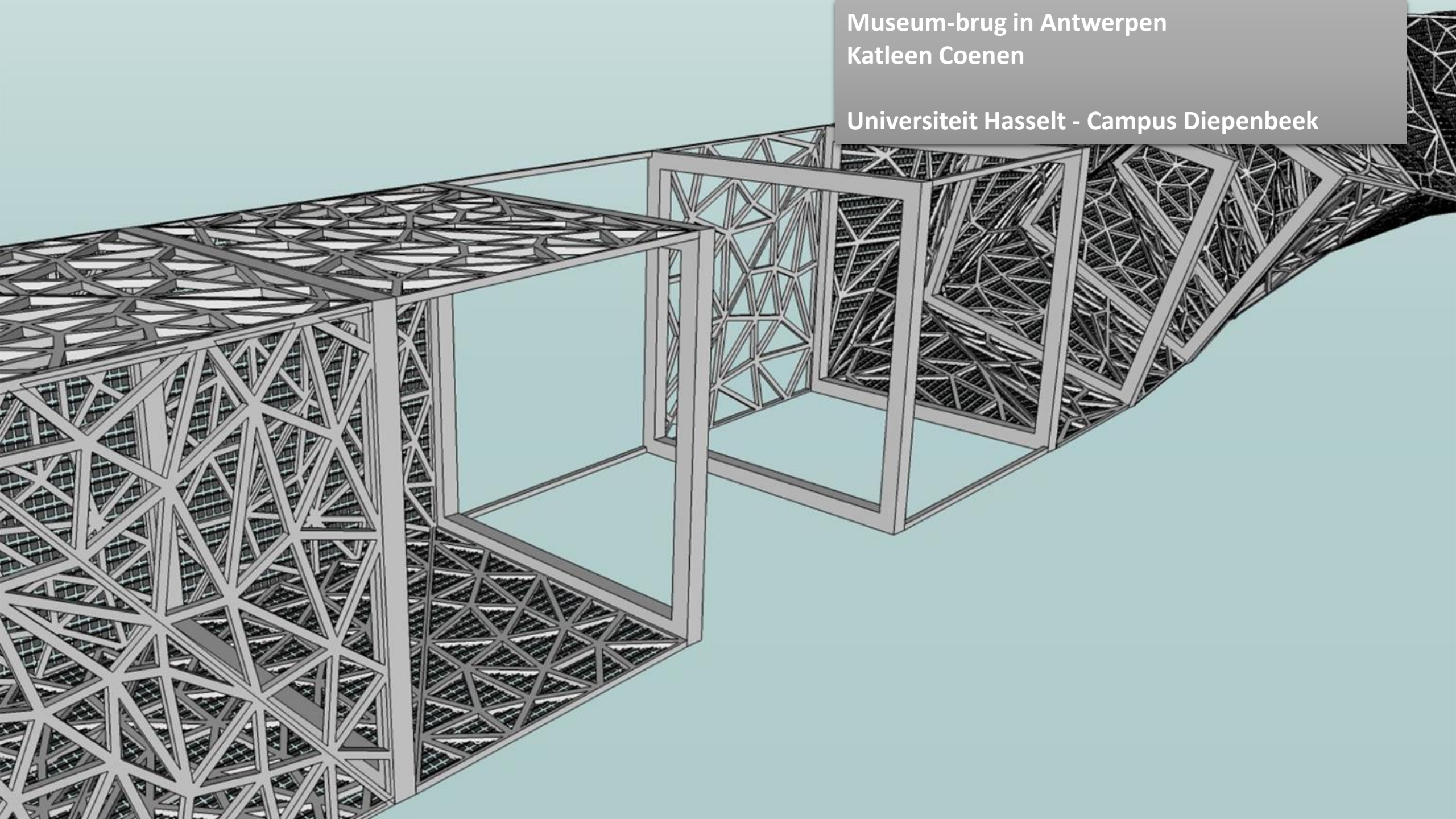







UZ Gent : extra buitenruimte  
Tuur Deltomme, Olivier Pareyn, Tim Van Eeckhout

UGent





UZ Gent : extra buitenruimte  
Tuur Deltomme, Olivier Pareyn, Tim Van Eeckhout  
UGent





UZ Gent : extra buitenruimte  
Tuur Deltomme, Olivier Pareyn, Tim Van Eeckhout

UGent





UZ Gent : extra buitenruimte  
Tuur Deltomme, Olivier Pareyn, Tim Van Eeckhout  
UGent



UZ Gent : extra buitenruimte  
Tuur Deltomme, Olivier Pareyn, Tim Van Eeckhout  
UGent







FASHION DEPOT

FASHIONWEEK  
FASHIONWEEK  
BERNARD CHAN RAFFLE  
OCT 17-19





Hazard-Cheratte : 'fashiondepot'  
Kimberley Vandenborne  
Universiteit Hasselt - Campus Diepenbeek





Hazard-Cheratte : 'fashiondepot'  
Kimberley Vandenborne  
Universiteit Hasselt - Campus Diepenbeek





Hazard-Cheratte : 'fashiondepot'  
Kimberley Vandenborne  
Universiteit Hasselt - Campus Diepenbeek

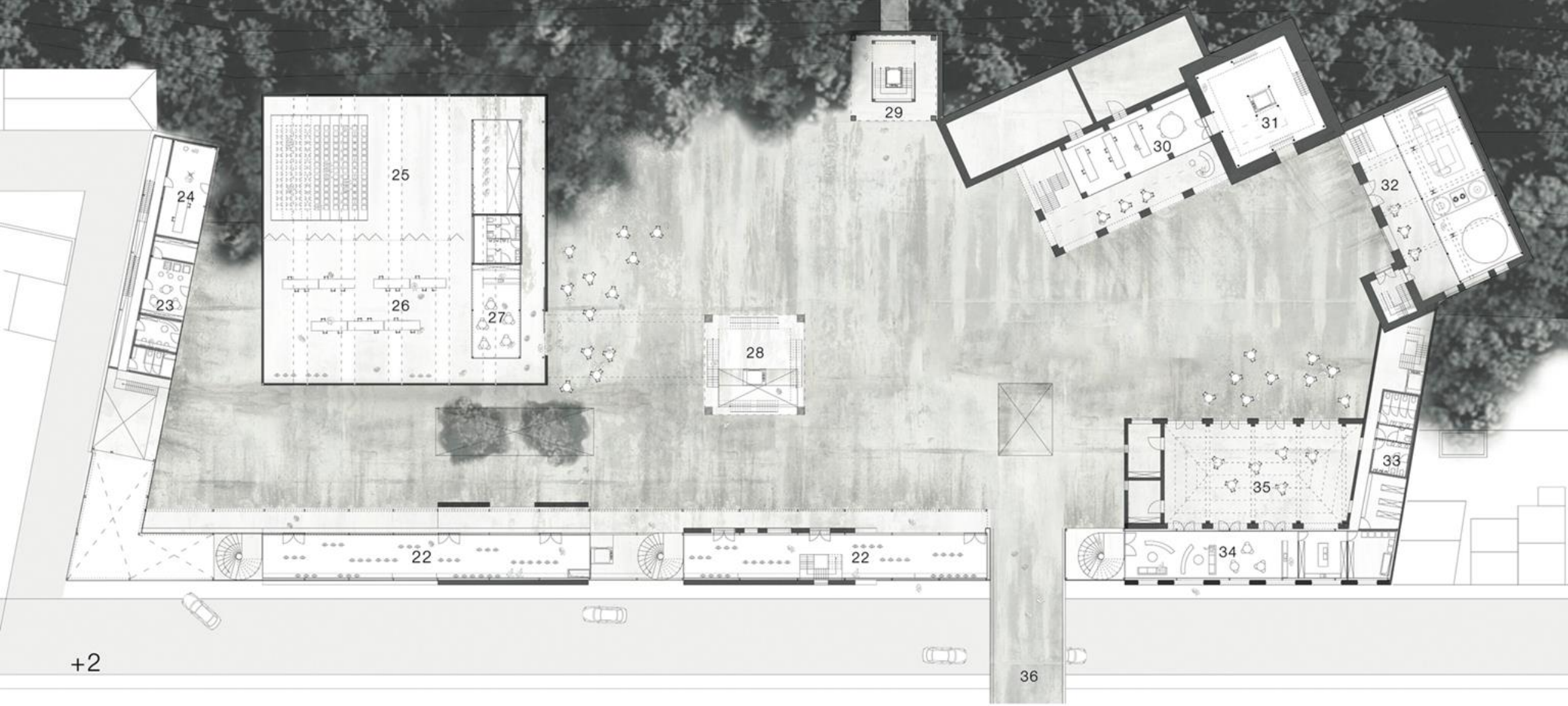



Hazard-Cheratte : 'fashiondepot'  
Kimberley Vandenborne

Universiteit Hasselt - Campus Diepenbeek





Hazard-Cheratte : 'fashiondepot'  
Kimberley Vandenborne

Universiteit Hasselt - Campus Diepenbeek





Hazard-Cheratte : 'fashiondepot'  
Kimberley Vandenborne

Universiteit Hasselt - Campus Diepenbeek

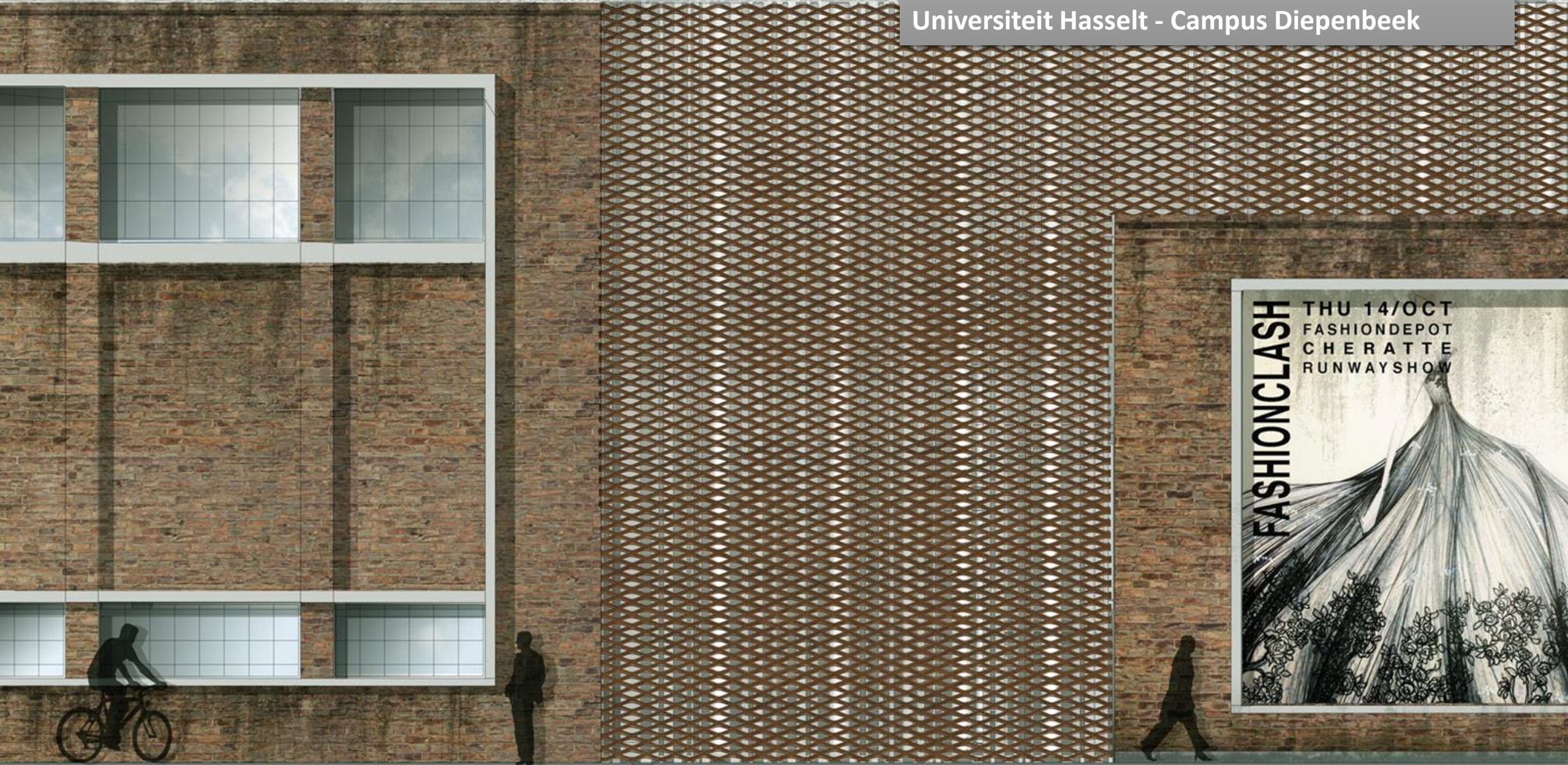





And the winners are...



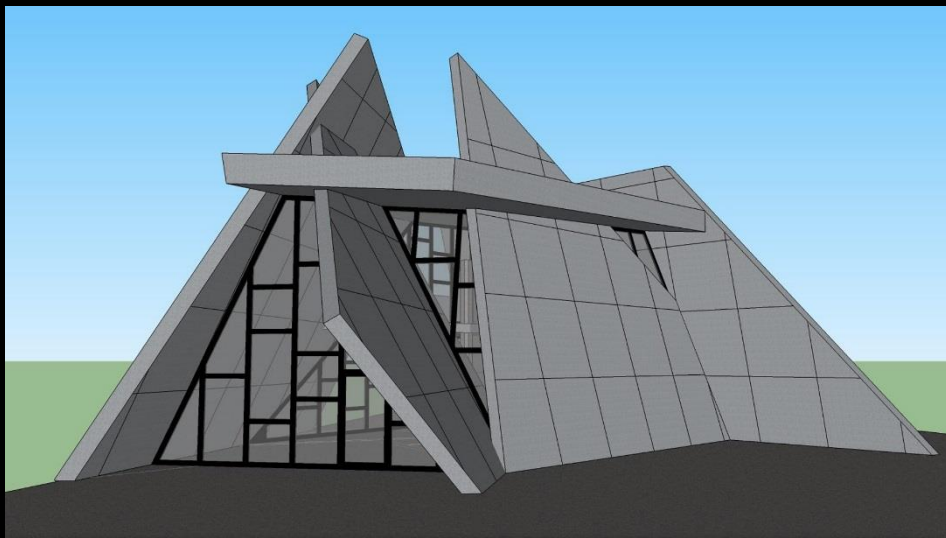

**Paviljoen Jubelpark**  
Anton Leonov, Celia Tesseur  
KU Leuven - Campus Sint-Lucas



**Museum-brug in Antwerpen**  
Katleen Coenen  
Universiteit Hasselt - Campus Diepenbeek



**UZ Gent : extra buitenruimte**  
Tuur Deltomme, Olivier Pareyn, Tim Van Eeckhout  
UGent

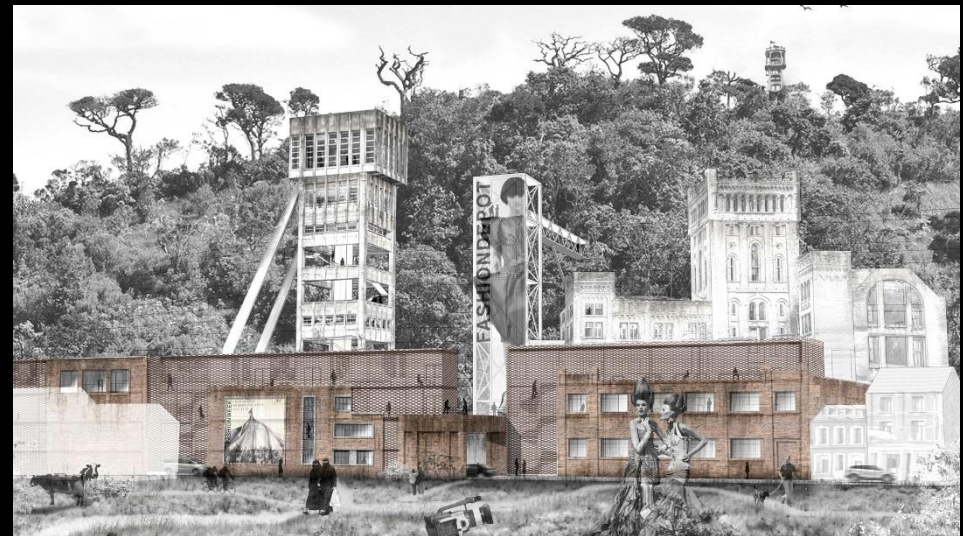

**Hazard-Cheratte : 'fashiondepot'**  
Kimberley Vandeborne  
Universiteit Hasselt - Campus Diepenbeek



